

**Data sheet | Item number: 769-181**

1-conductor/1-pin carrier terminal block; with 2 jumper positions; for DIN-rail  
35 x 15 and 35 x 7.5; 4 mm<sup>2</sup>; CAGE CLAMP®; 4,00 mm<sup>2</sup>; gray

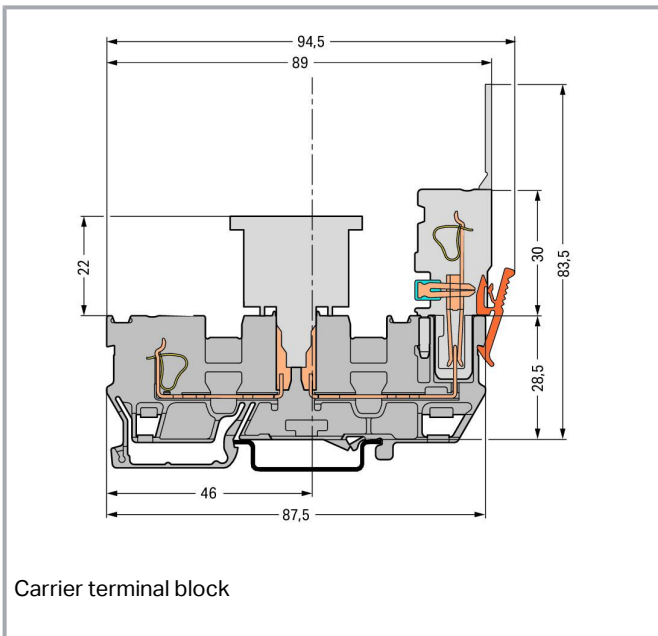

[www.wago.com/769-181](http://www.wago.com/769-181)

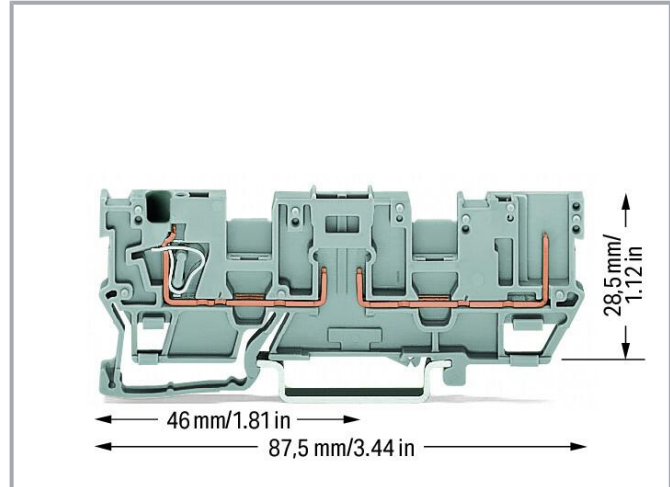
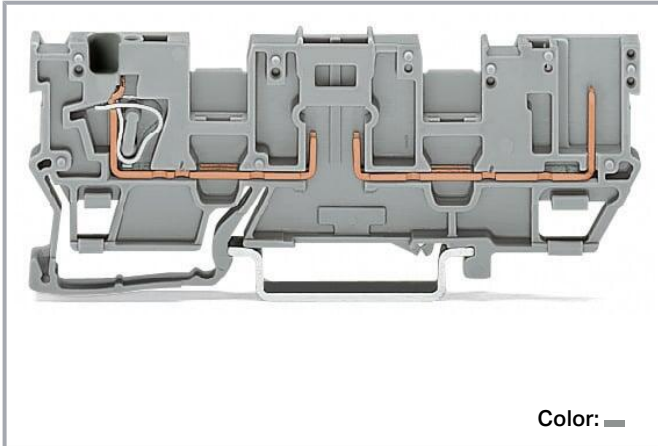

**Data  
Notes**

Safety information

2-conductor female plugs cannot be used.

Subject to changes. Please also observe the further product documentation!

WAGO GmbH & Co. KG  
Hansastr. 27  
32423 Minden  
Phone: +49571 887-0 | Fax: +49571 887-169  
Email: [info.de@wago.com](mailto:info.de@wago.com) | Web: [www.wago.com](http://www.wago.com)

Do you have any questions about our products?  
We are always happy to take your call at +49 (571) 887-44222.



## Electrical data

### Ratings per IEC/EN

Nominal voltage (III/3)	400 V
Rated impulse voltage (III/3)	6 kV
Rated current	16 A
Legend (ratings)	(III / 3) $\triangleq$ Overvoltage category III / Pollution degree 3

### Power loss

Power loss, per pole (potential)	0.256 W
Rated current $I_N$ for specified power loss	16 A
Resistance value for specified, current-dependent power loss	0.001 $\Omega$

### Connection data

Connection points	1
Total number of potentials	2
Number of levels	1

### Connection 1

Connection technology	CAGE CLAMP <sup>®</sup>
Number of connection points	1
Actuation type	Operating tool
Connectable conductor materials	Copper
Nominal cross-section	4 mm <sup>2</sup> / 12 AWG
Solid conductor	0.08 ... 4 mm <sup>2</sup> / 28 ... 12 AWG
Fine-stranded conductor	0.08 ... 4 mm <sup>2</sup> / 28 ... 12 AWG
Strip length	8 ... 9 mm / 0.31 ... 0.35 inches
Pole number	2
Wiring direction	Front-entry wiring

### Connection 2

Number of connection points 2	1
-------------------------------	---

### Physical data

Width	5 mm / 0.197 inches
-------	---------------------

Subject to changes. Please also observe the further product documentation!



Height	87.5 mm / 3.445 inches
Depth from upper-edge of DIN-rail	28.5 mm / 1.122 inches

### Mechanical Data

Design	horizontal type
Mounting type	DIN-35 rail
Marking level	Center marking

### Material Data

Note (material data)	Information on material specifications can be found here
Color	gray
Material group	I
Insulation material	Polyamide (PA66)
Flammability class per UL94	V0
Fire load	0.168 MJ
Weight	8 g

### Environmental requirements

Processing temperature	-35 ... +85 °C
Continuous operating temperature	-60 ... +105 °C

### Commercial data

Product Group	18 (X-COM-System)
eCl@ss 10.0	27-14-11-20
eCl@ss 9.0	27-14-11-20
ETIM 8.0	EC000897
ETIM 7.0	EC000897
PU (SPU)	50 pcs
Packaging type	box
Country of origin	DE
GTIN	4044918934725
Customs tariff number	85366990990





### Environmental Product Compliance

RoHS Compliance Status	Compliant, No Exemption
------------------------	-------------------------



Subject to changes. Please also observe the further product documentation!

## Approvals / Certificates

### General approvals

Logo	Approval	Additional Approval Text	Certificate name
	CCA DEKRA Certification B.V.	EN 60947	NTR NL-7626
	CSA DEKRA Certification B.V.	C22.2 No. 158	1101144
	KEMA/KEUR DEKRA Certification B.V.	EN 60947	2190419.01
	UL Underwriters Laboratories Inc.	UL 1977	E 45171
	UR Underwriters Laboratories Inc.	UL 1059	E45172

### Declarations of conformity and manufacturer's declarations

Logo	Approval	Additional Approval Text	Certificate name
	EU-Declaration of Conformity WAGO GmbH & Co. KG	-	-
	UK-Declaration of Conformity WAGO GmbH & Co. KG	-	-

### Approvals for marine applications

Logo	Approval	Additional Approval Text	Certificate name
	ABS American Bureau of Shipping	EN 60947	20-HG1941090-

Subject to changes. Please also observe the further product documentation!



DNV GL

Det Norske Veritas, Germanischer Lloyd

TAE00001V2

## Counterpart



Item no. 769-101

1-conductor female connector; CAGE CLAMP®; 4 mm<sup>2</sup>; Pin spacing 5 mm; 1-pole; coding finger; 4,00 mm<sup>2</sup>; gray[www.wago.com/769-101](http://www.wago.com/769-101)

## Required accessories

### End plate

#### End plate



Item no.: 769-311

End and intermediate plate; 1.1 mm thick; gray

[www.wago.com/769-311](http://www.wago.com/769-311)

Item no.: 769-312

End and intermediate plate; 1.1 mm thick; orange

[www.wago.com/769-312](http://www.wago.com/769-312)

## Optional accessories

### Carrier rail

#### Mounting accessories



Item no.: 210-197

Steel carrier rail; 35 x 15 mm; 1.5 mm thick; 2 m long; slotted; similar to EN 60715; silver-colored

[www.wago.com/210-197](http://www.wago.com/210-197)

Item no.: 210-198

Copper carrier rail; 35 x 15 mm; 2.3 mm thick; 2 m long; unslotted; according to EN 60715; copper-colored

[www.wago.com/210-198](http://www.wago.com/210-198)

Item no.: 210-504

Steel carrier rail; 35 x 7.5 mm; 1 mm thick; 2 m long; slotted; galvanized; according to EN 60715; silver-colored

[www.wago.com/210-504](http://www.wago.com/210-504)

Item no.: 210-505

Steel carrier rail; 35 x 7.5 mm; 1 mm thick; 2 m long; unslotted; galvanized; according to EN 60715; silver-colored

[www.wago.com/210-505](http://www.wago.com/210-505)

Item no.: 210-506

Steel carrier rail; 35 x 15 mm; 1.5 mm thick; 2 m long; unslotted; galvanized; similar to EN 60715; silver-colored

[www.wago.com/210-506](http://www.wago.com/210-506)

Item no.: 210-508

Subject to changes. Please also observe the further product documentation!

WAGO GmbH &amp; Co. KG

Hansastr. 27

32423 Minden

Phone: +49571 887-0 | Fax: +49571 887-169

Email: [info.de@wago.com](mailto:info.de@wago.com) | Web: [www.wago.com](http://www.wago.com)

Do you have any questions about our products?

We are always happy to take your call at +49 (571) 887-44222.



Steel carrier rail; 35 x 15 mm; 1.5 mm thick; 2 m long; slotted; galvanized; similar to EN 60715; silver-colored

[www.wago.com/210-508](http://www.wago.com/210-508)

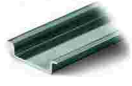

**Item no.: 210-113**

Steel carrier rail; 35 x 7.5 mm; 1 mm thick; 2 m long; unslotted; according to EN 60715; silver-colored

[www.wago.com/210-113](http://www.wago.com/210-113)



**Item no.: 210-118**

Steel carrier rail; 35 x 15 mm; 2.3 mm thick; 2 m long; unslotted; according to EN 60715; silver-colored

[www.wago.com/210-118](http://www.wago.com/210-118)



**Item no.: 210-112**

Steel carrier rail; 35 x 7.5 mm; 1 mm thick; 2 m long; slotted; according to EN 60715; "Hole width 25 mm; silver-colored

[www.wago.com/210-112](http://www.wago.com/210-112)



**Item no.: 210-114**

Steel carrier rail; 35 x 15 mm; 1.5 mm thick; 2 m long; unslotted; similar to EN 60715; silver-colored

[www.wago.com/210-114](http://www.wago.com/210-114)



**Item no.: 210-115**

Steel carrier rail; 35 x 7.5 mm; 1 mm thick; 2 m long; slotted; according to EN 60715; "Hole width 18 mm; silver-colored

[www.wago.com/210-115](http://www.wago.com/210-115)

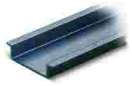

**Item no.: 210-196**

Aluminum carrier rail; 35 x 8.2 mm; 1.6 mm thick; 2 m long; unslotted; similar to EN 60715; silver-colored

[www.wago.com/210-196](http://www.wago.com/210-196)

## Coding

### Coding

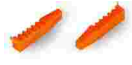

**Item no.: 769-435**

Coding pin; for coding of female plugs; for carrier terminal blocks / male connectors; orange

[www.wago.com/769-435](http://www.wago.com/769-435)

## Ferrule

### Ferrule



**Item no.: 216-101**

Ferrule; Sleeve for 0.5 mm<sup>2</sup> / AWG 22; uninsulated; electro-tin plated; silver-colored

[www.wago.com/216-101](http://www.wago.com/216-101)



**Item no.: 216-104**

Ferrule; Sleeve for 1.5 mm<sup>2</sup> / AWG 16; uninsulated; electro-tin plated; silver-colored

[www.wago.com/216-104](http://www.wago.com/216-104)



**Item no.: 216-102**

Ferrule; Sleeve for 0.75 mm<sup>2</sup> / AWG 20; uninsulated; electro-tin plated; silver-colored

[www.wago.com/216-102](http://www.wago.com/216-102)



**Item no.: 216-103**

Ferrule; Sleeve for 1 mm<sup>2</sup> / AWG 18; uninsulated; electro-tin plated

[www.wago.com/216-103](http://www.wago.com/216-103)



**Item no.: 216-203**

Ferrule; Sleeve for 1 mm<sup>2</sup> / AWG 18; insulated; electro-tin plated; red

[www.wago.com/216-203](http://www.wago.com/216-203)



**Item no.: 216-206**

Ferrule; Sleeve for 2.5 mm<sup>2</sup> / AWG 14; insulated; electro-tin plated; blue

[www.wago.com/216-206](http://www.wago.com/216-206)



**Item no.: 216-202**

Ferrule; Sleeve for 0.75 mm<sup>2</sup> / 18 AWG; insulated; electro-tin plated; gray

[www.wago.com/216-202](http://www.wago.com/216-202)

Subject to changes. Please also observe the further product documentation!

WAGO GmbH & Co. KG

Hansastr. 27





32423 Minden

Phone: +49571 887-0 | Fax: +49571 887-169

Email: [info.de@wago.com](mailto:info.de@wago.com) | Web: [www.wago.com](http://www.wago.com)



Do you have any questions about our products?

We are always happy to take your call at +49 (571) 887-44222.

	<b>Item no.: 216-204</b> Ferrule; Sleeve for 1.5 mm <sup>2</sup> / AWG 16; insulated; electro-tin plated; black	<a href="http://www.wago.com/216-204">www.wago.com/216-204</a>
	<b>Item no.: 216-201</b> Ferrule; Sleeve for 0.5 mm <sup>2</sup> / 20 AWG; insulated; electro-tin plated; white	<a href="http://www.wago.com/216-201">www.wago.com/216-201</a>
	<b>Item no.: 216-301</b> Ferrule; Sleeve for 0.25 mm <sup>2</sup> / AWG 24; insulated; electro-tin plated; yellow	<a href="http://www.wago.com/216-301">www.wago.com/216-301</a>
	<b>Item no.: 216-302</b> Ferrule; Sleeve for 0.34 mm <sup>2</sup> / 22 AWG; insulated; electro-tin plated; light turquoise	<a href="http://www.wago.com/216-302">www.wago.com/216-302</a>





## Mounting

### Mounting accessories

	<b>Item no.: 209-106</b> Mounting carrier; for isolated mounting on DIN 35 rails; gray	<a href="http://www.wago.com/209-106">www.wago.com/209-106</a>
	<b>Item no.: 249-116</b> Screwless end stop; 6 mm wide; for DIN-rail 35 x 15 and 35 x 7.5; gray	<a href="http://www.wago.com/249-116">www.wago.com/249-116</a>



## Push-in type wire jumper

### Jumper

	<b>Item no.: 249-123</b> Push-in type wire jumper; 0.75 mm <sup>2</sup> ; insulated; 180 mm long; black	<a href="http://www.wago.com/249-123">www.wago.com/249-123</a>
	<b>Item no.: 249-126</b> Push-in type wire jumper; 0.75 mm <sup>2</sup> ; insulated; 110 mm long; black	<a href="http://www.wago.com/249-126">www.wago.com/249-126</a>
	<b>Item no.: 249-127</b> Push-in type wire jumper; 0.75 mm <sup>2</sup> ; insulated; 250 mm long; black	<a href="http://www.wago.com/249-127">www.wago.com/249-127</a>
	<b>Item no.: 249-125</b> Push-in type wire jumper; insulated; 60 mm long; black	<a href="http://www.wago.com/249-125">www.wago.com/249-125</a>

## Insulation stop

### Insulation stop

	<b>Item no.: 769-470</b> Insulation stop; 0.08 - 0.2 mm <sup>2</sup> "s" (0.14 mm <sup>2</sup> "f-st"); 5 pieces/strip; white	<a href="http://www.wago.com/769-470">www.wago.com/769-470</a>
	<b>Item no.: 769-471</b> Insulation stop; 0.25 - 0.5 mm <sup>2</sup> ; 5 pieces/strip; light gray	<a href="http://www.wago.com/769-471">www.wago.com/769-471</a>
	<b>Item no.: 769-472</b> Insulation stop; 0.75 - 1 mm <sup>2</sup> ; 5 pieces/strip; dark gray	<a href="http://www.wago.com/769-472">www.wago.com/769-472</a>

## Protective warning marker

### Cover

Subject to changes. Please also observe the further product documentation!



**Item no.: 280-415**  
Protective warning marker; for 5 terminal blocks; with high-voltage symbol, black; yellow

[www.wago.com/280-415](http://www.wago.com/280-415)

**Tool**

Operating tool



**Item no.: 210-720**  
Operating tool; Blade: 3.5 x 0.5 mm; with a partially insulated shaft; multicoloured

[www.wago.com/210-720](http://www.wago.com/210-720)

**Jumpers**

Jumper



**Item no.: 280-402**  
Jumper; insulated; gray

[www.wago.com/280-402](http://www.wago.com/280-402)



**Item no.: 280-409**  
Jumper; insulated; gray

[www.wago.com/280-409](http://www.wago.com/280-409)



**Item no.: 780-454**  
Staggered jumper; from 1 to 4; insulated; gray

[www.wago.com/780-454](http://www.wago.com/780-454)



**Item no.: 780-452**  
Staggered jumper; from 1 to 2; insulated; gray

[www.wago.com/780-452](http://www.wago.com/780-452)



**Item no.: 780-453**  
Staggered jumper; from 1 to 3; insulated; gray

[www.wago.com/780-453](http://www.wago.com/780-453)



**Item no.: 780-457**  
Staggered jumper; from 1 to 7; insulated; gray

[www.wago.com/780-457](http://www.wago.com/780-457)



**Item no.: 780-456**  
Staggered jumper; from 1 to 6; insulated; gray

[www.wago.com/780-456](http://www.wago.com/780-456)



**Item no.: 780-455**  
Staggered jumper; from 1 to 5; insulated; gray

[www.wago.com/780-455](http://www.wago.com/780-455)



**Item no.: 780-458**  
Staggered jumper; from 1 to 8; insulated; gray

[www.wago.com/780-458](http://www.wago.com/780-458)

**End plate**

End plate



**Item no.: 769-314**  
Separator plate; 1.1 mm thick; oversized; orange

[www.wago.com/769-314](http://www.wago.com/769-314)

**Cover**

Cover



**Item no.: 769-438**  
Pin cover; with marker slot for miniature WSB; gray

[www.wago.com/769-438](http://www.wago.com/769-438)

Subject to changes. Please also observe the further product documentation!



**Item no.: 769-439**

Pin cover; with marker slot for miniature WSB; orange

[www.wago.com/769-439](http://www.wago.com/769-439)**Marking accessories****Marker****Item no.: 2009-145**

Mini-WSB Inline; for Smart Printer; 1700 pieces on roll; stretchable 5 - 5.2 mm; plain; snap-on type; white

[www.wago.com/2009-145](http://www.wago.com/2009-145)**Item no.: 248-501**

Mini-WSB marking card; as card; not stretchable; plain; snap-on type; white

[www.wago.com/248-501](http://www.wago.com/248-501)**Plugs****Component module with a fuse****Item no.: 286-890**

Component module with fuse; for (5 x 20) mm microfuse; Nominal voltage: 24 VAC/DC; gray

[www.wago.com/286-890](http://www.wago.com/286-890)**Item no.: 286-891**

Component module with fuse; for (5 x 20) mm microfuse; Nominal voltage: 230 VAC/DC; gray

[www.wago.com/286-891](http://www.wago.com/286-891)**Neon indicator module****Item no.: 280-801/281-417**

Component plug; for carrier terminal blocks; 2-pole; 5 mm wide; gray

[www.wago.com/280-801/281-417](http://www.wago.com/280-801/281-417)**Item no.: 280-801/281-418**

Component plug; for carrier terminal blocks; 2-pole; 5 mm wide; gray

[www.wago.com/280-801/281-418](http://www.wago.com/280-801/281-418)**Solid-state relay module****Item no.: 286-721**

Optocoupler module; Nominal input voltage: 24 VDC; Output voltage range: 15 ... 30 VDC; Limiting continuous current: 5 A; 3-wire connection/low-side switching; Red status indicator; Module width: 15 mm; gray

[www.wago.com/286-721](http://www.wago.com/286-721)**Item no.: 286-723**

Optocoupler module; Nominal input voltage: 24 VDC; Output voltage range: 15 ... 30 VDC; Limiting continuous current: 4 A; 3-wire connection/high-side switching; Red status indicator; Module width: 15 mm; gray

[www.wago.com/286-723](http://www.wago.com/286-723)**Item no.: 286-752**

Optocoupler module; Nominal input voltage: 24 VDC; Output voltage range: 20 ... 30 VDC; Limiting continuous current: 0.5 A; 3-wire connection/high-side switching; Frequency: 25 kHz; Red status indicator; Module width: 15 mm; gray

[www.wago.com/286-752](http://www.wago.com/286-752)**Item no.: 286-752/002-000**

Optocoupler module; Red status indicator; gray

[www.wago.com/286-752/002-000](http://www.wago.com/286-752/002-000)**Item no.: 286-792**

Optocoupler module; Red status indicator; gray

[www.wago.com/286-792](http://www.wago.com/286-792)

Subject to changes. Please also observe the further product documentation!

WAGO GmbH &amp; Co. KG

Hansastr. 27

32423 Minden

Phone: +49571 887-0 | Fax: +49571 887-169

Email: [info.de@wago.com](mailto:info.de@wago.com) | Web: [www.wago.com](http://www.wago.com)

Do you have any questions about our products?

We are always happy to take your call at +49 (571) 887-44222.

	<b>Item no.: 286-794</b> Optocoupler module; Nominal input voltage: 24 VDC; Red status indicator; gray	<a href="http://www.wago.com/286-794">www.wago.com/286-794</a>
	<b>Item no.: 286-791</b> Optocoupler module; Nominal input voltage: 24 VDC; Output voltage range: 20 ... 60 VDC; Limiting continuous current: 0.1 A; 2-wire connection; Frequency: 3 kHz; Red status indicator; Module width: 10 mm; gray	<a href="http://www.wago.com/286-791">www.wago.com/286-791</a>
Component module with diode		
	<b>Item no.: 286-805</b> Component module with diode; with 5 pcs; Diode 1N4007; with common anode; gray	<a href="http://www.wago.com/286-805">www.wago.com/286-805</a>
	<b>Item no.: 286-807</b> Component module with diode; with 7 pcs; Diode 1N4007; with common anode; gray	<a href="http://www.wago.com/286-807">www.wago.com/286-807</a>
	<b>Item no.: 286-809</b> Component module with diode; with 9 pcs; Diode 1N4007; with common anode; gray	<a href="http://www.wago.com/286-809">www.wago.com/286-809</a>
Timer relay module		
	<b>Item no.: 286-604/004-000</b> Timer relay module; Nominal input voltage: 24 VDC; Limiting continuous current: 6 A; On-delay: 10 ... 100 s; Red status indicator; Module width: 20 mm; gray	<a href="http://www.wago.com/286-604/004-000">www.wago.com/286-604/004-000</a>
	<b>Item no.: 286-640/004-000</b> Timer relay module; Nominal input voltage: 24 VDC; Limiting continuous current: 5 A; Railway; Multifunction; Red status indicator; Module width: 20 mm; gray	<a href="http://www.wago.com/286-640/004-000">www.wago.com/286-640/004-000</a>
	<b>Item no.: 286-640</b> Timer relay module; Nominal input voltage: 24 VDC; Limiting continuous current: 6 A; Railway; Multifunction/Multitime; Yellow status indicator; Module width: 6 mm; gray	<a href="http://www.wago.com/286-640">www.wago.com/286-640</a>
LED plug		
	<b>Item no.: 280-801/281-413</b> Component plug; for carrier terminal blocks; 2-pole; LED (red); 24 VDC; 5 mm wide; gray	<a href="http://www.wago.com/280-801/281-413">www.wago.com/280-801/281-413</a>
	<b>Item no.: 280-801/281-414</b> Component plug; for carrier terminal blocks; 2-pole; LED (red); 48 VDC; 5 mm wide; gray	<a href="http://www.wago.com/280-801/281-414">www.wago.com/280-801/281-414</a>
	<b>Item no.: 280-801/281-415</b> Component plug; for carrier terminal blocks; 2-pole; LED (red); 5 mm wide; gray	<a href="http://www.wago.com/280-801/281-415">www.wago.com/280-801/281-415</a>
	<b>Item no.: 280-801/281-416</b> Component plug; for carrier terminal blocks; 2-pole; LED (red); 5 mm wide; gray	<a href="http://www.wago.com/280-801/281-416">www.wago.com/280-801/281-416</a>
Bridge rectifier module		
	<b>Item no.: 286-830</b> Bridge rectifier module; Input voltage: 24 VAC; with varistor protective circuit; gray	<a href="http://www.wago.com/286-830">www.wago.com/286-830</a>
Current flow monitoring module		







Subject to changes. Please also observe the further product documentation!

	<b>Item no.: 286-664</b> Current flow monitoring module; AC currents; Monitoring range: 0.2 A – 3 A; 1 changeover contact; light gray	<a href="http://www.wago.com/286-664">www.wago.com/286-664</a>
	<b>Item no.: 286-665</b> Current flow monitoring module; AC currents; Monitoring range: 1 A – 10 A; 1 changeover contact; light gray	<a href="http://www.wago.com/286-665">www.wago.com/286-665</a>
	<b>Item no.: 286-662</b> Current flow monitoring module; DC currents; Monitoring range: 0.4 A – 3.5 A; 1 make contact; light gray	<a href="http://www.wago.com/286-662">www.wago.com/286-662</a>
	<b>Item no.: 286-661</b> Current flow monitoring module; AC currents; light gray	<a href="http://www.wago.com/286-661">www.wago.com/286-661</a>
Switching module		
	<b>Item no.: 286-896</b> Switching module; with momentary switch; Switching voltage: 250 VAC; Switching current: 6 A; gray	<a href="http://www.wago.com/286-896">www.wago.com/286-896</a>
	<b>Item no.: 286-895</b> Switching module; with changeover rocker switch; Switching voltage: 250 VAC; Switching current: 6 A; gray	<a href="http://www.wago.com/286-895">www.wago.com/286-895</a>
Fuse plug		
	<b>Item no.: 280-854/281-413</b> Fuse plug; with soldered miniature fuse; with indicator lamp; LED (red); DC 15 - 30 V; 1 A FF; 5 mm wide; gray	<a href="http://www.wago.com/280-854/281-413">www.wago.com/280-854/281-413</a>
	<b>Item no.: 280-854/281-415</b> Fuse plug; with soldered miniature fuse; with indicator lamp; LED (red); AC 15 - 30 V; 1 A FF; 5 mm wide; gray	<a href="http://www.wago.com/280-854/281-415">www.wago.com/280-854/281-415</a>
	<b>Item no.: 280-856/281-415</b> Fuse plug; with soldered miniature fuse; with indicator lamp; LED (red); AC 15 - 30 V; 2 A FF; 5 mm wide; gray	<a href="http://www.wago.com/280-856/281-415">www.wago.com/280-856/281-415</a>
	<b>Item no.: 280-856/281-414</b> Fuse plug; with soldered miniature fuse; with indicator lamp; LED (red); DC 30 - 65 V; 2 A FF; 5 mm wide; gray	<a href="http://www.wago.com/280-856/281-414">www.wago.com/280-856/281-414</a>
	<b>Item no.: 280-856</b> Fuse plug; with soldered miniature fuse; 2 A FF; 5 mm wide; gray	<a href="http://www.wago.com/280-856">www.wago.com/280-856</a>
	<b>Item no.: 280-854/281-414</b> Fuse plug; with soldered miniature fuse; with indicator lamp; LED (red); DC 30 - 65 V; 1 A FF; 5 mm wide; gray	<a href="http://www.wago.com/280-854/281-414">www.wago.com/280-854/281-414</a>
	<b>Item no.: 280-856/281-413</b> Fuse plug; with soldered miniature fuse; with indicator lamp; LED (red); DC 15 - 30 V; 2 A FF; 5 mm wide; gray	<a href="http://www.wago.com/280-856/281-413">www.wago.com/280-856/281-413</a>
	<b>Item no.: 281-511</b> Fuse plug; with pull-tab; for miniature metric fuses 5 x 20 mm and 5 x 25 mm; without blown fuse indication; 6 mm wide; gray	<a href="http://www.wago.com/281-511">www.wago.com/281-511</a>
	<b>Item no.: 281-512/281-501</b>	

Subject to changes. Please also observe the further product documentation!

Fuse plug; with pull-tab; for miniature metric fuses 5 x 20 mm and 5 x 25 mm; with LED indicator; 24 V AC/DC; 6 mm wide; gray

[www.wago.com/281-512](http://www.wago.com/281-512)  
/281-501

	<b>Item no.: 281-512</b> Fuse plug; with pull-tab; for miniature metric fuses 5 x 20 mm and 5 x 25 mm; with port for LED; 6 mm wide; gray	<a href="http://www.wago.com/281-512">www.wago.com/281-512</a>
	<b>Item no.: 281-512/281-418</b> Fuse plug; with pull-tab; for miniature metric fuses 5 x 20 mm and 5 x 25 mm; with blown fuse indication by neon lamp; 120 V; 6 mm wide; gray	<a href="http://www.wago.com/281-512/281-418">www.wago.com/281-512/281-418</a>
	<b>Item no.: 281-512/281-417</b> Fuse plug; with pull-tab; for miniature metric fuses 5 x 20 mm and 5 x 25 mm; with blown fuse indication by neon lamp; 230 V; 6 mm wide; gray	<a href="http://www.wago.com/281-512/281-417">www.wago.com/281-512/281-417</a>
	<b>Item no.: 280-850/281-414</b> Fuse plug; with soldered miniature fuse; with indicator lamp; LED (red); DC 30 - 65 V; 250 mA FF; 5 mm wide; gray	<a href="http://www.wago.com/280-850/281-414">www.wago.com/280-850/281-414</a>
	<b>Item no.: 280-850/281-413</b> Fuse plug; with soldered miniature fuse; with indicator lamp; LED (red); DC 15 - 30 V; 250 mA FF; 5 mm wide; gray	<a href="http://www.wago.com/280-850/281-413">www.wago.com/280-850/281-413</a>
	<b>Item no.: 280-850/281-415</b> Fuse plug; with soldered miniature fuse; with indicator lamp; LED (red); AC 15 - 30 V; 250 mA FF; 5 mm wide; gray	<a href="http://www.wago.com/280-850/281-415">www.wago.com/280-850/281-415</a>
	<b>Item no.: 280-852/281-413</b> Fuse plug; with soldered miniature fuse; with indicator lamp; LED (red); DC 15 - 30 V; 500 mA FF; 5 mm wide; gray	<a href="http://www.wago.com/280-852/281-413">www.wago.com/280-852/281-413</a>
	<b>Item no.: 280-852/281-414</b> Fuse plug; with soldered miniature fuse; with indicator lamp; LED (red); DC 30 - 65 V; 500 mA FF; 5 mm wide; gray	<a href="http://www.wago.com/280-852/281-414">www.wago.com/280-852/281-414</a>
	<b>Item no.: 280-852/281-415</b> Fuse plug; with soldered miniature fuse; with indicator lamp; LED (red); AC 15 - 30 V; 500 mA FF; 5 mm wide; gray	<a href="http://www.wago.com/280-852/281-415">www.wago.com/280-852/281-415</a>
	<b>Item no.: 280-854</b> Fuse plug; with soldered miniature fuse; 1 A FF; 5 mm wide; gray	<a href="http://www.wago.com/280-854">www.wago.com/280-854</a>
	<b>Item no.: 280-852</b> Fuse plug; with soldered miniature fuse; 500 mA FF; 5 mm wide; gray	<a href="http://www.wago.com/280-852">www.wago.com/280-852</a>
	<b>Item no.: 280-850</b> Fuse plug; with soldered miniature fuse; 250 mA FF; 5 mm wide; gray	<a href="http://www.wago.com/280-850">www.wago.com/280-850</a>
<b>Diode plug</b>		
	<b>Item no.: 280-801/281-411</b> Component plug; for carrier terminal blocks; 2-pole; with diode 1N4007; 5 mm wide; gray	<a href="http://www.wago.com/280-801/281-411">www.wago.com/280-801/281-411</a>

Subject to changes. Please also observe the further product documentation!

	<b>Item no.: 280-801/281-421</b> Component plug; for carrier terminal blocks; 2-pole; with LED and recovery diode; 5 mm wide; gray	<a href="http://www.wago.com/280-801/281-421">www.wago.com/280-801/281-421</a>
	<b>Item no.: 280-801/281-420</b> Component plug; for carrier terminal blocks; 2-pole; with LED and recovery diode; 5 mm wide; gray	<a href="http://www.wago.com/280-801/281-420">www.wago.com/280-801/281-420</a>
Component module with LED		
	<b>Item no.: 286-822</b> Component module with LED; Red LED; with common cathode	<a href="http://www.wago.com/286-822">www.wago.com/286-822</a>
AND gate module		
	<b>Item no.: 286-826</b> AND gate module with 6 inputs; light gray	<a href="http://www.wago.com/286-826">www.wago.com/286-826</a>
Relay module		
	<b>Item no.: 286-307/004-000</b> Relay module; Nominal input voltage: 110 VDC; 1 changeover contact; Limiting continuous current: 3 A; Railway; Red status indicator; Module width: 15 mm; gray	<a href="http://www.wago.com/286-307/004-000">www.wago.com/286-307/004-000</a>
	<b>Item no.: 286-328/004-000</b> Relay module; Nominal input voltage: 24 VDC; 2 make contact; Limiting continuous current: 6 A; Railway; Red status indicator; Module width: 20 mm; gray	<a href="http://www.wago.com/286-328/004-000">www.wago.com/286-328/004-000</a>
	<b>Item no.: 286-312</b> Relay module; Nominal input voltage: 24 VDC; 2 changeover contacts; Limiting continuous current: 7 A; Red status indicator; Module width: 20 mm; gray	<a href="http://www.wago.com/286-312">www.wago.com/286-312</a>
	<b>Item no.: 286-328</b> Relay module; Nominal input voltage: 24 VDC; 2 make contact; Limiting continuous current: 6 A; Red status indicator; Module width: 20 mm; gray	<a href="http://www.wago.com/286-328">www.wago.com/286-328</a>
	<b>Item no.: 286-312/004-000</b> Relay module; Nominal input voltage: 24 VDC; 2 changeover contacts; Limiting continuous current: 5 A; Railway; Red status indicator; Module width: 20 mm; gray	<a href="http://www.wago.com/286-312/004-000">www.wago.com/286-312/004-000</a>
	<b>Item no.: 286-316</b> Relay module; Nominal input voltage: 220 VDC; 2 changeover contacts; Limiting continuous current: 7 A; Red status indicator; Module width: 20 mm; gray	<a href="http://www.wago.com/286-316">www.wago.com/286-316</a>
	<b>Item no.: 286-320</b> Relay module; Nominal input voltage: 24 VDC; 1 break and 1 make contact; Limiting continuous current: 6 A; Red status indicator; Module width: 20 mm; gray	<a href="http://www.wago.com/286-320">www.wago.com/286-320</a>
	<b>Item no.: 286-336/001-000</b> Relay module; Nominal input voltage: 24 VDC; 2 break and 2 make contacts; Red status indicator; Module width: 25 mm; gray	<a href="http://www.wago.com/286-336/001-000">www.wago.com/286-336/001-000</a>
	<b>Item no.: 286-352/004-000</b> Relay module; Nominal input voltage: 24 VDC; 4 make contacts; Limiting continuous current: 5 A; Railway; Red status indicator; Module width: 25 mm; gray	<a href="http://www.wago.com/286-352/004-000">www.wago.com/286-352/004-000</a>
	<b>Item no.: 286-344/004-000</b> Relay module; Nominal input voltage: 24 VDC; 3 break contacts and 1 make contact; Railway; Red	

Subject to changes. Please also observe the further product documentation!

status indicator; Module width: 25 mm; gray

[www.wago.com/286-344/004-000](http://www.wago.com/286-344/004-000)

 **Item no.: 286-364/004-000**  
Relay module; Nominal input voltage: 24 VDC; 1 make contact; Limiting continuous current: 3 A; Railway; Red status indicator; Module width: 10 mm; gray [www.wago.com/286-364/004-000](http://www.wago.com/286-364/004-000)

 **Item no.: 286-368/004-000**  
Relay module; Nominal input voltage: 24 VDC; 1 break contact; Limiting continuous current: 3 A; Railway; Red status indicator; Module width: 10 mm; gray [www.wago.com/286-368/004-000](http://www.wago.com/286-368/004-000)

 **Item no.: 286-364**  
Relay module; Nominal input voltage: 24 VDC; 1 make contact; Limiting continuous current: 5 A; Red status indicator; Module width: 10 mm; gray [www.wago.com/286-364](http://www.wago.com/286-364)

 **Item no.: 286-376**  
Relay module; Nominal input voltage: 24 VDC; 1 make contact; Limiting continuous current: 5 A; for switching higher DC loads; Red status indicator; Module width: 15 mm; gray [www.wago.com/286-376](http://www.wago.com/286-376)

 **Item no.: 286-368**  
Relay module; Nominal input voltage: 24 VDC; 1 break contact; Limiting continuous current: 5 A; Red status indicator; Module width: 10 mm; gray [www.wago.com/286-368](http://www.wago.com/286-368)

 **Item no.: 286-394/004-000**  
Relay module; Nominal input voltage: 24 VDC; 1 changeover contact; Limiting continuous current: 1 A; with gold contacts; Railway; Red status indicator; Module width: 15 mm; light gray [www.wago.com/286-394/004-000](http://www.wago.com/286-394/004-000)

 **Item no.: 286-380**  
Bistable relay module; Nominal input voltage: 24 VDC; 1 changeover contact; Limiting continuous current: 6 A; Red status indicator; Module width: 15 mm; gray [www.wago.com/286-380](http://www.wago.com/286-380)

 **Item no.: 286-320/004-000**  
Relay module; Nominal input voltage: 24 VDC; 1 break and 1 make contact; Railway; Red status indicator; Module width: 20 mm; gray [www.wago.com/286-320/004-000](http://www.wago.com/286-320/004-000)

 **Item no.: 286-573**  
Latching relay module; Nominal input voltage: 24 VDC; 1 changeover contact; Limiting continuous current: 6 A; Red status indicator; Module width: 15 mm [www.wago.com/286-573](http://www.wago.com/286-573)

 **Item no.: 286-304**  
Relay module; Nominal input voltage: 24 VDC; 1 changeover contact; Limiting continuous current: 7 A; Red status indicator; Module width: 15 mm; gray [www.wago.com/286-304](http://www.wago.com/286-304)

 **Item no.: 286-304/004-000**  
Relay module; Nominal input voltage: 24 VDC; 1 changeover contact; Limiting continuous current: 6 A; Railway; Red status indicator; Module width: 15 mm; gray [www.wago.com/286-304/004-000](http://www.wago.com/286-304/004-000)

 **Item no.: 286-508**  
Relay module; Nominal input voltage: 230 VAC; 1 changeover contact; Limiting continuous current: 7 A; Red status indicator; Module width: 15 mm; gray [www.wago.com/286-508](http://www.wago.com/286-508)

 **Item no.: 286-507**  
Relay module; Nominal input voltage: 115 VAC; 1 changeover contact; Limiting continuous current: 7 A; Red status indicator; Module width: 15 mm; gray [www.wago.com/286-507](http://www.wago.com/286-507)

 **Item no.: 286-516**  
Relay module; Nominal input voltage: 230 VAC; 2 changeover contacts; Limiting continuous current: 7 [www.wago.com/286-516](http://www.wago.com/286-516)

Subject to changes. Please also observe the further product documentation!

WAGO GmbH &amp; Co. KG

Hansastr. 27

32423 Minden

Phone: +49571 887-0 | Fax: +49571 887-169

Email: [info.de@wago.com](mailto:info.de@wago.com) | Web: [www.wago.com](http://www.wago.com)

Do you have any questions about our products?

We are always happy to take your call at +49 (571) 887-44222.

A; Red status indicator; Module width: 15 mm; gray

S0 interface power supply unit

	<b>Item no.: 286-742</b> S0 interface power supply; Input voltage: 230 VAC; S0 interface	<a href="http://www.wago.com/286-742">www.wago.com/286-742</a>
--	---	--

Empty component plug housing

	<b>Item no.: 280-801</b> Empty component plug housing; gray	<a href="http://www.wago.com/280-801">www.wago.com/280-801</a>
--	--	--

	<b>Item no.: 280-802</b> Empty component plug housing; gray	<a href="http://www.wago.com/280-802">www.wago.com/280-802</a>
---	--	--

	<b>Item no.: 280-804</b> Empty component plug housing; 10 mm wide; Type 3; 4-pole; gray	<a href="http://www.wago.com/280-804">www.wago.com/280-804</a>
---	--	--

	<b>Item no.: 286-112</b> Empty component plug housing; Type 11; 20 mm wide; 8-pole; gray	<a href="http://www.wago.com/286-112">www.wago.com/286-112</a>
--	---	--

	<b>Item no.: 286-113</b> Empty component plug housing; Type 12; 25 mm wide; 10-pole; gray	<a href="http://www.wago.com/286-113">www.wago.com/286-113</a>
--	--	--

	<b>Item no.: 286-110</b> Empty component plug housing; Type 9; 10 mm wide; 4-pole; gray	<a href="http://www.wago.com/286-110">www.wago.com/286-110</a>
--	--	--

	<b>Item no.: 286-111</b> Empty component plug housing; Type 10; 15 mm wide; 6-pole; gray	<a href="http://www.wago.com/286-111">www.wago.com/286-111</a>
--	---	--

	<b>Item no.: 786-102</b> Empty component plug housing; Type 15; 20 mm wide; 8-pole; gray	<a href="http://www.wago.com/786-102">www.wago.com/786-102</a>
--	---	--

	<b>Item no.: 786-101</b> Empty component plug housing; Type 14; 15 mm wide; 6-pole; gray	<a href="http://www.wago.com/786-101">www.wago.com/786-101</a>
--	---	--

	<b>Item no.: 786-103</b> Empty component plug housing; Type 16; 25 mm wide; 10-pole; gray	<a href="http://www.wago.com/786-103">www.wago.com/786-103</a>
--	--	--

Testing and measuring

Testing accessories

	<b>Item no.: 210-136</b> Test plug; 2 mm Ø; with 500 mm cable; red	<a href="http://www.wago.com/210-136">www.wago.com/210-136</a>
--	---	--

	<b>Item no.: 280-418</b> Test plug module; modular; suitable for all WAGO 280 and 780 Series rail-mounted terminal blocks with jumper slots in the current bar; gray	<a href="http://www.wago.com/280-418">www.wago.com/280-418</a>
--	---	--

	<b>Item no.: 280-404</b> Test plug adapter; 5 mm wide; for test plug (2.3 mm Ø); suitable for 1.5 mm <sup>2</sup> - 4 mm <sup>2</sup> tbs; gray	<a href="http://www.wago.com/280-404">www.wago.com/280-404</a>
--	--	--

	<b>Item no.: 280-419</b> Spacer module; modular; bridging commoned terminal blocks; gray	<a href="http://www.wago.com/280-419">www.wago.com/280-419</a>
--	---	--

Subject to changes. Please also observe the further product documentation!



## Downloads

### Documentation

#### Bid Text

769-181 X81 - Datei	2019 Feb 19	xml 3.4 kB	Download
------------------------	-------------	---------------	----------

769-181 doc - Datei	2017 Oct 2	doc 25.1 kB	Download
------------------------	------------	----------------	----------

#### Additional Information

Technical Section Technical explanations		pdf 2.2 MB	Download
---	--	---------------	----------

## CAD/CAE-Data

### CAD data

2D/3D Models 769-181		URL	Download
----------------------	--	-----	----------

### CAE data

EPLAN Data Portal 769-181		URL	Download
---------------------------	--	-----	----------

WSCAD Universe 769-181		URL	Download
------------------------	--	-----	----------

ZUKEN Portal 769-181		URL	Download
----------------------	--	-----	----------

## Environmental Product Compliance

### Compliance Search

Environmental Product Compliance 769-181 1-conductor/1-pin carrier terminal block; with 2 jumper positions; for DIN-rail 35 x 15 and 35 x 7.5; 4 mm <sup>2</sup> ; CAGE CLAMP®; 4,00 mm <sup>2</sup> ; gray		URL	Download
--	--	-----	----------

## Installation Notes

### Installation

Subject to changes. Please also observe the further product documentation!

WAGO GmbH & Co. KG  
Hansastr. 27  
32423 Minden  
Phone: +49571 887-0 | Fax: +49571 887-169  
Email: [info.de@wago.com](mailto:info.de@wago.com) | Web: [www.wago.com](http://www.wago.com)

Do you have any questions about our products?  
We are always happy to take your call at +49 (571) 887-44222.



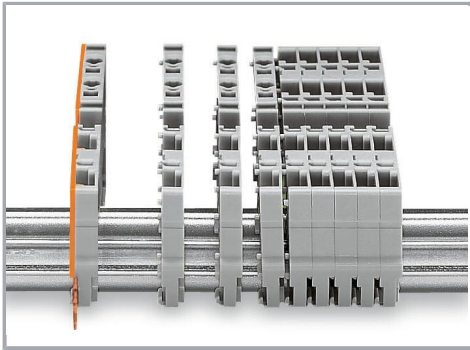

Snap individual carrier terminal blocks onto the DIN-rail and slide together.

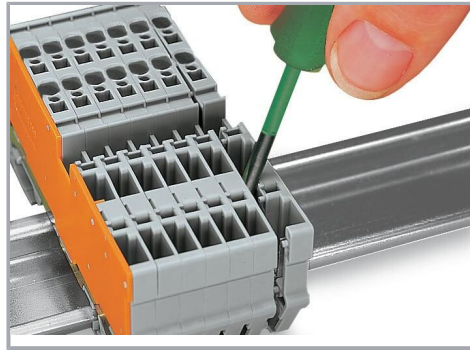

Open the assembly by laterally sliding a block via operating tool and remove terminal block via release lever.

#### Conductor termination

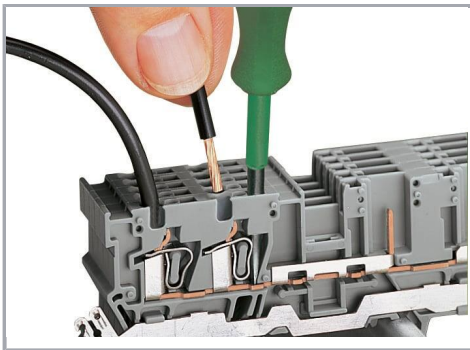

#### CAGE CLAMP® connection

Carrier terminal block: Insert/remove conductor via operating tool (3.5 x 0.5 mm blade).

#### Commoning

Subject to changes. Please also observe the further product documentation!

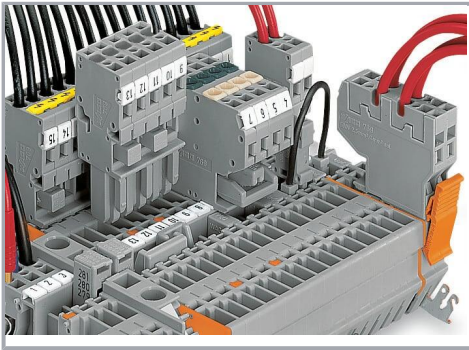

Commoning with adjacent or staggered jumpers.

Push jumpers down until fully inserted.

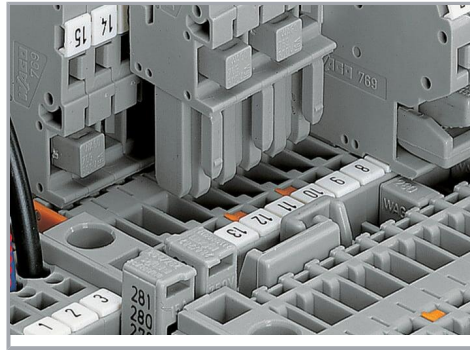

Commoning carrier terminal blocks via staggered jumpers.

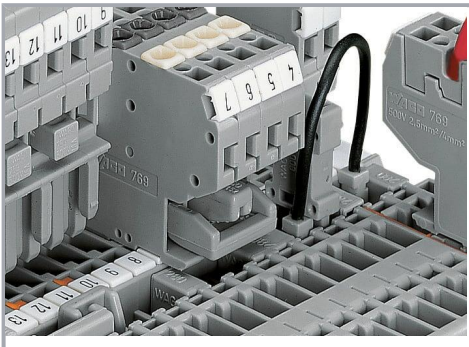

Commoning a 2-conductor female plug via staggered jumper and carrier terminal blocks via adjacent jumpers.

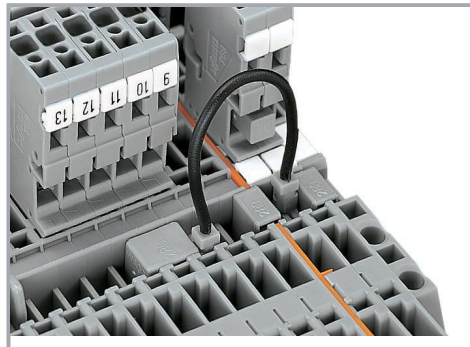

Commoning carrier terminal blocks via push-in type wire jumpers or adjacent jumpers – even over an intermediate plate.

Subject to changes. Please also observe the further product documentation!

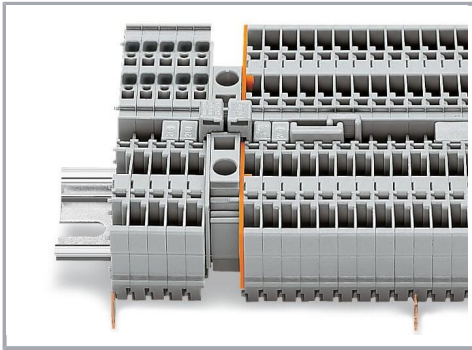

Commoning "supply terminal blocks" (up to 10 mm<sup>2</sup>/8 AWG) with carrier terminal blocks via step-down jumpers.

#### Coding

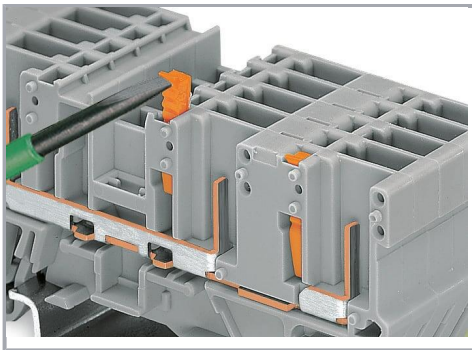

Snap coding pin in proper direction on carrier terminal block.

Shown: Coding pin removal from carrier terminal block.

#### Locking system

Subject to changes. Please also observe the further product documentation!

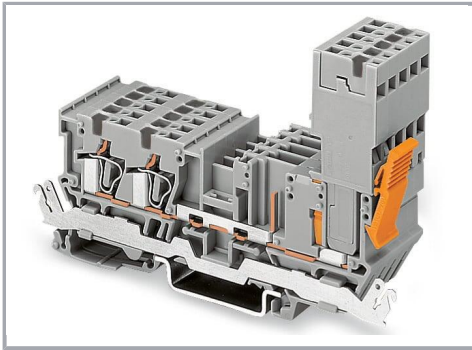

Securing a female plug via locking lever on the terminal block side.

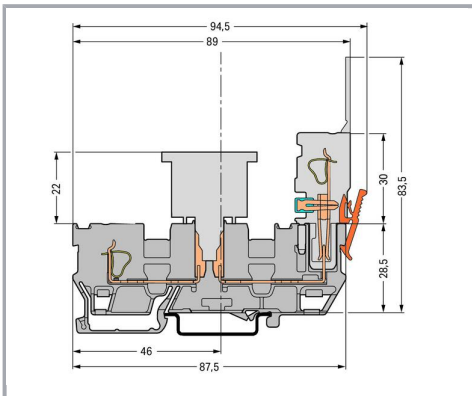

Carrier terminal block

Subject to changes. Please also observe the further product documentation!

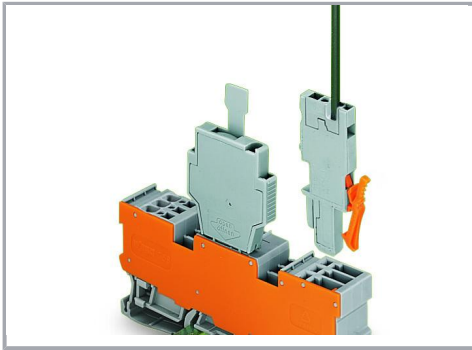

1-conductor/1-pin carrier terminal block with two jumper positions

1-connector female plug, straight\*

Fuse plug, 6 mm wide (every other terminal block)

\*1-conductor angled female plug is also possible!

## Product family

**X-COM**

[Show all products from the family](#)

Subject to changes. Please also observe the further product documentation!